



**BROCHURE**

**UNISTRUT<sup>®</sup>**

**SEISMIC BRACING COMPONENTS**



A PART OF



# UNISTRUT® Seismic Bracing Components

UNISTRUT® Bracing Systems are designed for the resisting of load requirements therefore keeping non-structural components intact and operational. Each Authority having Jurisdiction (AHJ) will address the requirements through their design professional using the Building Code and standards covering the type of structure and location. This "Quick View" document shows some of the standard configurations of Bracing and the components that can make up the support. Remember your system if planned ahead can use non-retrofit fittings, but if you are adding your Bracing to an existing system retrofit fittings are available (look for the SPF fittings.) The sizing of the anchor, rod and channel members all must be confirmed to qualify the support. Typical systems support: piping, conduit, cable tray, ducts and equipment.

The State with one of the highest standards of Seismic Bracing requirements is California. The agency controlling systems used in "Essential Facilities", in California is the Office of Statewide Health and Planning" (OSHPD.) They review and approve Bracing systems and allow the manufactures to publish an approved OPA (OSHPD Pre-Approved) document which takes you through the design process. UNISTRUT has an OPA-0120 for use in designs through the CBC2007 code. This document is available by going to [www.unistrutseismic.com](http://www.unistrutseismic.com). A newer submittal for the CBC2010 code is in Sacramento awaiting review and approval. This newer document is not yet published but pages can be supplied upon request. See the back cover for more details. Also available on this web site are the UNISTRUT General Engineering Catalog, and another Seismic application manual. All, in support of the UNISTRUT Systems.

## STANDARD BRACING FOR TRAPEZE SUPPORTS

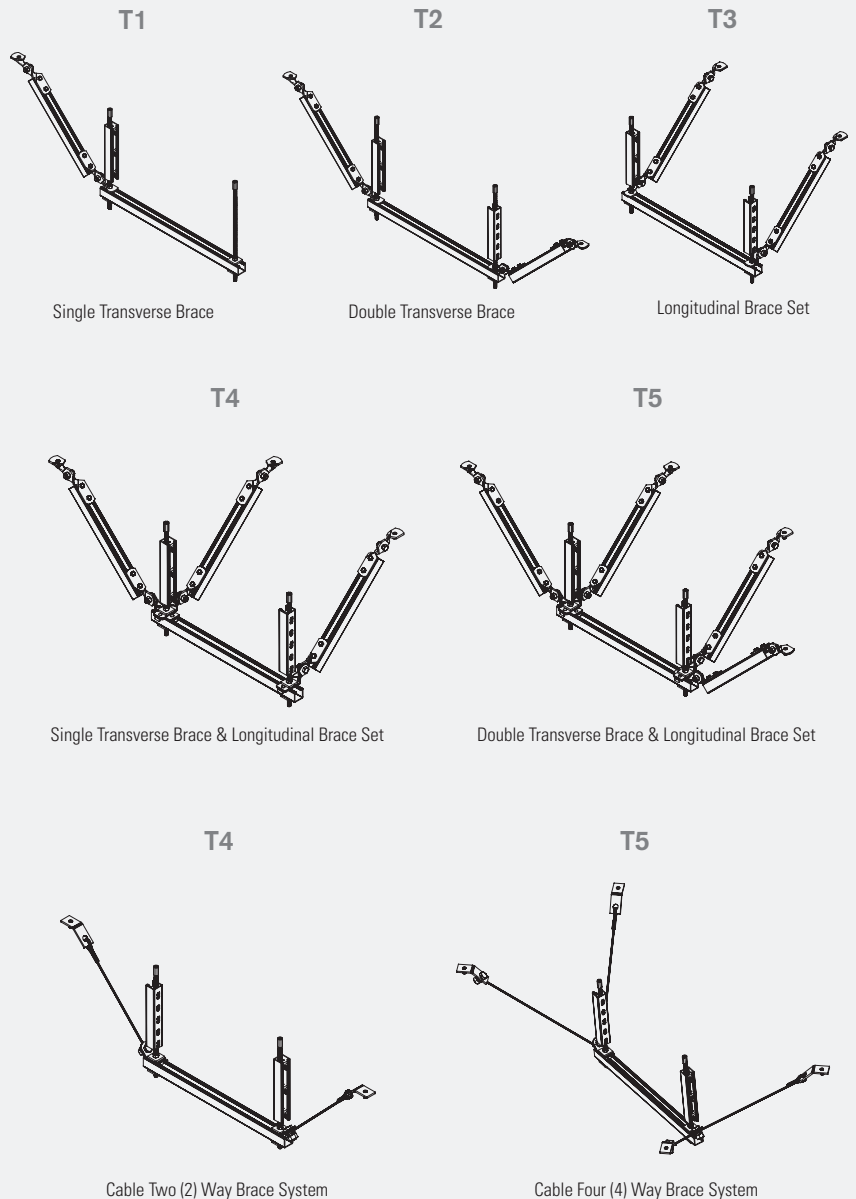

## CHANNELS

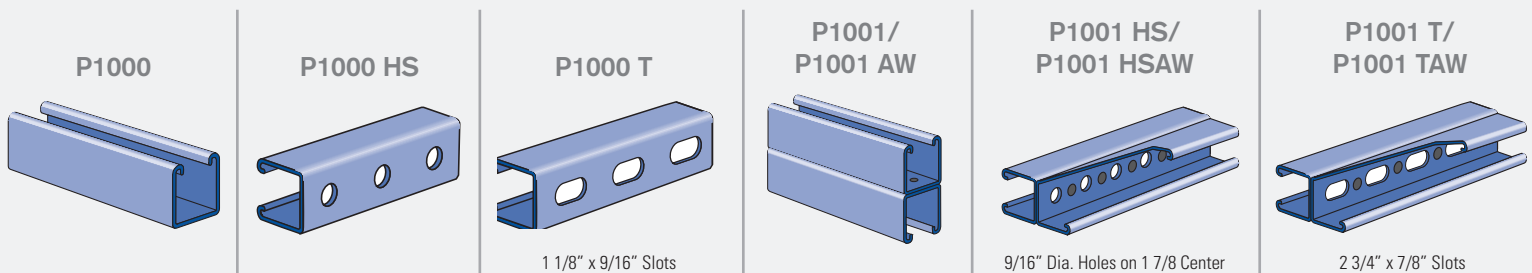

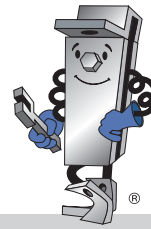

**UNISTRUT**

A PART OF **atkore**  
INTERNATIONAL

**SEISMIC PIVOT FITTINGS - RETROFITTABLE**

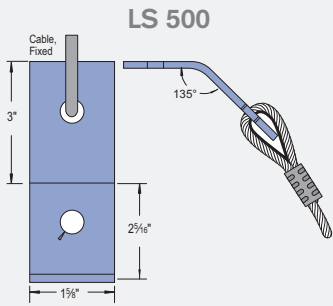

For rod sizes: 3/8", 1/2", 5/8", & 3/4"

**LS 410**

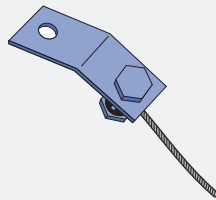

For rod sizes: 3/8", 1/2", 5/8", & 3/4"

**LS 502**

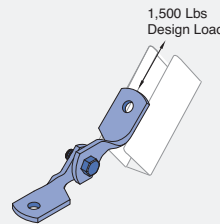

For rod sizes: 3/8", 1/2", 5/8", & 3/4"

**LS 503**

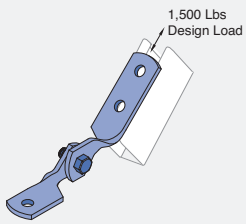

For rod sizes: 3/8", 1/2", 5/8", & 3/4"

**LS 504**

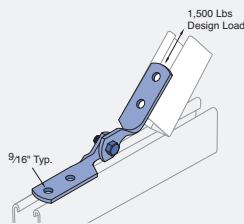

All holes sizes 9/16"

**P1354AW**

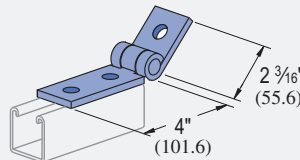

All holes sizes 9/16"

**P1843W**

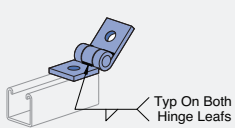

All holes sizes 9/16"

**P1354W**

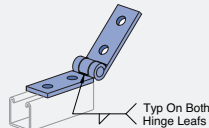

All holes sizes 9/16"

**LS103**

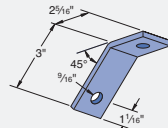

For rod sizes: 3/8", 1/2", 5/8", & 3/4"

**P1546 Series**

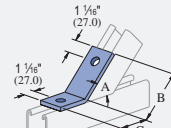

All holes sizes 9/16"

**STANDARD BRACING FOR TRAPEZE SUPPORTS**

**SPF 100**

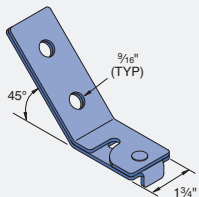

For rod sizes: 3/8", 1/2", 5/8", & 3/4"

**SPF 200**

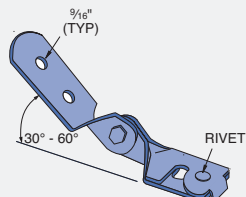

For rod sizes: 3/8", 1/2", 5/8", & 3/4"

**SPF 300**

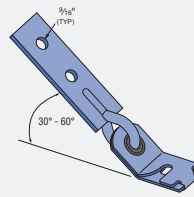

For rod sizes: 3/8", 1/2", 5/8", & 3/4"

**SPF 400**

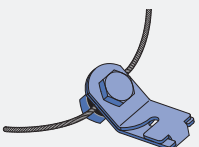

For rod sizes: 3/8", 1/2", 5/8", & 3/4"

**SPF 401**

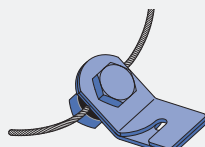

For rod sizes: 3/8", 1/2", 5/8", & 3/4"

Note: All SPF Fittings come with the proper rod size square washer

SPF (Seismic Pivot Fittings) are a Trademark of Lord & Sons Inc.

**ANCHOR (BRACE) POINT OPTION**

**"ROD ANCHOR" (TYPE 1 MOUNT)**

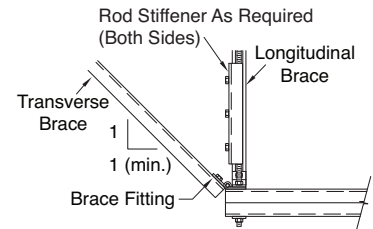

**"CHANNEL ANCHOR" (TYPE 2 MOUNT)**

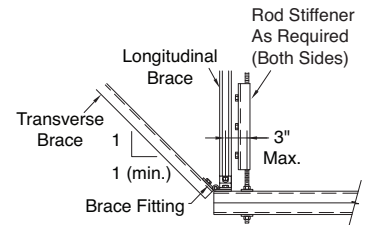

**"CHANNEL ANCHOR" (TYPE 2 MOUNT)**

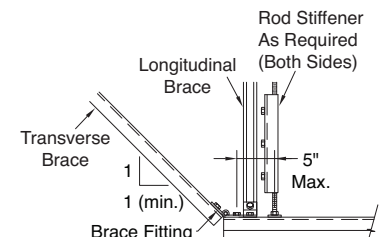

**TRANSVERSE & LONGITUDINAL BRACE OPTIONS**

**TRANSVERSE BRACE**

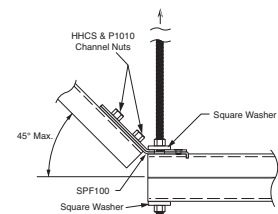

**LONGITUDINAL BRACE SET**

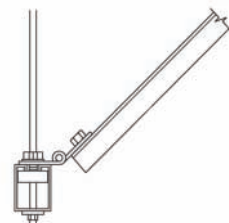

16100 South Lathrop Avenue

Harvey, IL 60426

TOLL-FREE / 800-882-5543

FAX / 708-339-7814

[www.unistrutseismic.com](http://www.unistrutseismic.com)



**Columbia-MBF™**



**KAF-TECH®**



**UNISTRUT®**



**TECTRONTube®**



**UNISTRUT®**  
Construction



**SprinkFLEX®**



**FLEXHEAD®**  
INDUSTRIES